



WS No. 19 Mark III

**This file has been down loaded from  
The Wireless-Set-No19 WEB site.**

**All files from this WEB site are free of charge.  
If you have been charged for this file then please  
contact the person you obtained it from as he/she  
has illegally obtained both the file and money they have  
charged you.....**

# Post Office Engineering Department

---

## TECHNICAL PAMPHLETS FOR WORKMEN

---

*Subject:*

### Magneto Exchanges—Multiple Type

ENGINEER-IN-CHIEF'S OFFICE  
1919

*(Reprinted July, 1925, including correction slips to date.)*

LONDON :

PRINTED AND PUBLISHED BY HIS MAJESTY'S STATIONERY OFFICE.

To be purchased directly from  
H.M. STATIONERY OFFICE at the following addresses: ADASTRAL HOUSE,  
KINGSWAY, LONDON, W.C.2; 28, ABINGDON STREET, LONDON, S.W.1;  
YORK STREET, MANCHESTER; 1, ST. ANDREW'S CRESCENT, CARDIFF;  
or 120, GEORGE STREET, EDINBURGH; or through any Bookseller.

[Reprinted 1926.]

Price 6d. net

==== LIST OF ====

# Technical Pamphlets for Workmen

=====

**GROUP A.**

1. Magnetism and Electricity.
2. Primary Batteries.
3. Technical Terms.
4. Test Boards.
5. Protective Fittings.
6. Measuring and Testing Instruments.
7. Sensitivity of Apparatus.

**GROUP B.**

1. Elementary Principles of Telegraphy and Systems up to Morse Duplex.
2. Telegraph Concentrators.
3. Wheatstone. Morse Keyboard Perforators.
4. Quadruplex. Telegraph Repeaters, Sx., Dx., and Quad.
5. Hughes Type-printing Telegraph.
6. Baudot Multiplex.
7. Western Electric Multiplex Murray Multiplex. Other Systems.
8. Fire Alarm Systems.

**GROUP C.**

1. General Principles of Wireless Transmission and Reception.

**GROUP D.**

1. Elementary Principles of Telephony.
2. Telephone Transmission. "Loading." Telephone Repeaters and Thermionic Valves.
3. Principles of Telephone Exchange Signalling.
4. Magneto Exchanges—Non-Multiple Type.
5. Magneto Exchanges—Multiple Type.
6. C.B.S. Exchanges—Non-Multiple Type.
7. C.B.S. Exchanges—Multiple Type.
8. C.B. Exchanges—No. 9 Type.
9. C.B. Exchanges—No. 10 Type.
10. C.B. Exchanges—No. 12 Type.
11. C.B. Exchanges—22 Volts.
12. C.B. Exchanges—40 Volts.
13. Trunk Telephone Exchanges.
14. Telephone Exchange Maintenance.
15. Telephone Testing Equipment.
16. Routine Testing for Telephone Exchanges.
17. Internal Cabling and Wiring.
18. Distribution Cases, M.D.F. and I.D.F.
19. Cord Repairs.
20. Superposed Circuits, Transformers, etc.
21. Call Offices.

*[Continued on page iii of Cover.]*

# MAGNETO EXCHANGES— MULTIPLE TYPE, (D. 5.)

---

---

*The following pamphlets in this series  
are of kindred interest :—*

- D. 1. Elementary Principles of Telephony.
- D. 2. Telephone Transmission. "Loading." Telephone Repeaters and Thermionic Valves.
- D. 3. Principles of Telephone Exchange Signalling.
- D.14. Telephone Exchange Maintenance.
- D.15. Telephone Testing Equipment.
- D.16. Routine Testing for Telephone Exchanges.
- D.17. Internal Cabling and Wiring.
- D.18. Distribution Cases, M.D.F. and I.D.F.
- D.19. Cord Repairs.
- D.21. Call Offices.
- F. 3. Subscribers' Apparatus, Magneto.
- F. 5. Private Branch Exchange.—C.B. Multiple No. 9.
- F. 6. Private Branch Exchange—Magneto.
- G. 1. Secondary Cells, Maintenance of.
- G. 2. Power Plant for Telegraph and Telephone Purposes.
- G. 3. Maintenance of Power Plant for Telegraph and Telephone Purposes.

# MAGNETO EXCHANGES— MULTIPLE TYPE

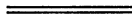

## TABLE OF CONTENTS.

	PAGE
MULTIPLE SWITCHBOARD ... ..	3
TEST BOARD ... ..	3
I.D.F. ... ..	6
METHOD OF CABLING ... ..	6
SERIES MULTIPLE ... ..	6
BRANCHING MULTIPLE ... ..	8
THE SWITCHBOARD ... ..	10
“ A ” OPERATOR’S POSITION . ... ..	11
WIRING OF MULTIPLE ... ..	12
JUNCTION WORKING ... ..	12
LAMP SIGNALLING ... ..	17
RINGING DISTRIBUTION .. ... ..	23

# MAGNETO EXCHANGES—MULTIPLE TYPE.

The principal items of Plant in this type of Exchange are:—  
**The Testboard** and the **Multiple Switchboard**. In the larger exchanges an **Intermediate Distributing Frame** is usually included.

## MULTIPLE SWITCHBOARD.

The Multiple Switchboard is an arrangement whereby every Subscriber's line is repeated or multiplied at short intervals so that each operator has every line within reach. There are two systems of multiple, one the *Series or Break Jack System*, and the other the *Branching System*. Both systems will be described later.

## TEST BOARD.

The Testboard usually is of the Cabinet pattern with two rows of Protector Strips placed on one side of the cabinet, one at the top and one at the bottom. The Test Jacks are placed on the other side in the bottom panel. The leading-in Cables are terminated on the Protector Strips and extended by means of Jumper Wires through the cross connection field at the top of the cabinet down to the test jacks.

Fig. 1 shows a Sectional elevation of a Testboard commonly used in Magneto Exchanges.

The Protector Strips are placed in two tiers between A and B, and C and D. The test jacks are placed between E and F.

The route of a jumper wire through the cross connecting field between a protector strip on the lower tier and a test jack is shown by the dotted line. The

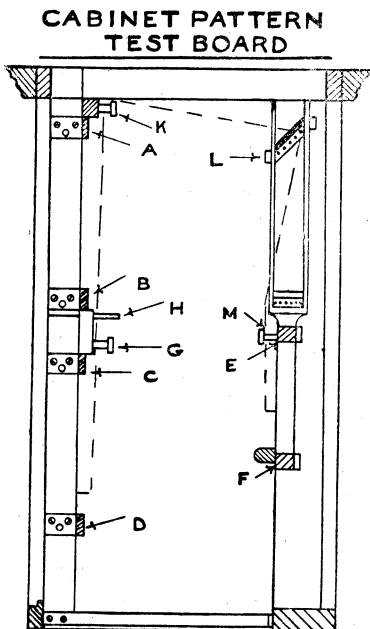

Fig. 1.

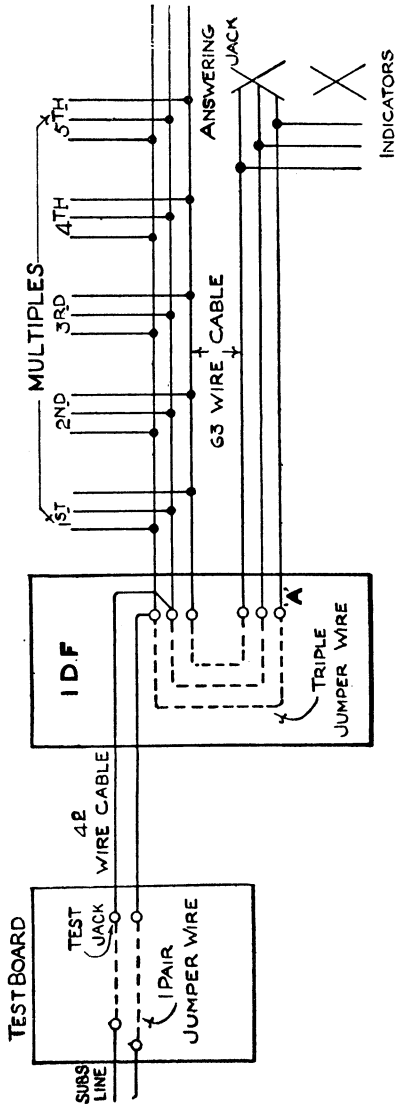

Fig. 2.

**BRANCHING MULTIPLE.**

**NOTE.**—In Lamp Calling Exchanges the Relays are sometimes connected to Point "A" instead of being bridged on to the Answering Jack, similar to the Indicators.

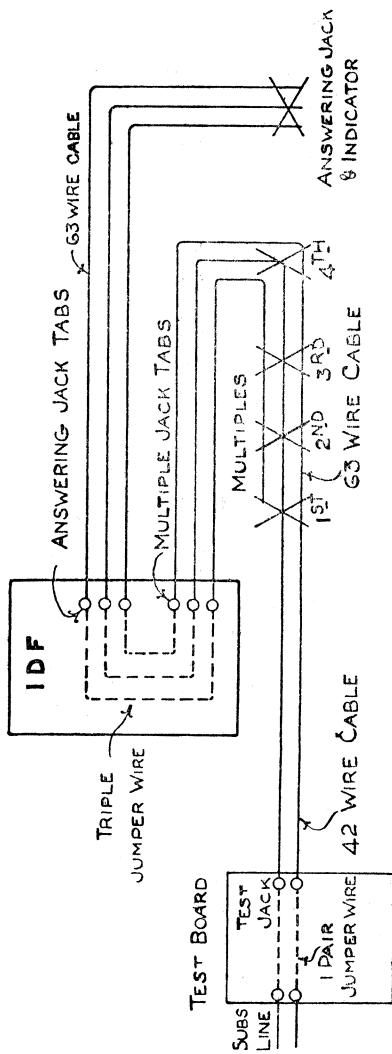

Fig. 3.

SERIES MULTIPLE.



jumper wire is of 1 pr. Flameproof Cable, and is passed first through the grid G, insulating ring H, grid K, across the top of the board and over one of the insulated bars L, through grid M to the test jack. The test jacks are in strips of 20, and the lines are carried forward to the Intermediate Distribution Frame or Switchboard by 42-wire cables.

### INTERMEDIATE DISTRIBUTION FRAME.

This is usually a separate fixture but may form part of the rear of the Switchboard Sections. It consists of two sets of soldering tabs with a cross connecting field between, and its purpose is to distribute the busy lines amongst the operators in order to equalise the operating load.

### METHOD OF CABLING.

In the case of an exchange with a **branching multiple**, the cables to the multiple jacks on the switchboard are taken from the Intermediate Distributing Frame strip on which the test jack cables terminate.

Where the **series multiple** system is employed, the cables from the test jacks are first taken direct to the multiple, and after having passed through the multiple they go to the Intermediate Distributing Frame, or, where no I.D.F. is fitted, direct to the answering jacks and indicators.

A reference to Figures 2 and 3 will make clear the methods of cabling when an I.D.F. is fitted, and it will be noted that the multiple and answering jack cables are terminated on separate sets of cross connection tabs; thus the line circuit is not complete unless a triple jumper wire is run between the two sets of tabs. **Any answering jack, with its calling indicator or relay, may be cross-connected to any multiple jack.** By this means, the subscribers' numbers do not run consecutively on the answering positions, and the low numbered subscribers, usually the busiest, are distributed throughout the switchboard as desired.

### SERIES MULTIPLE.

Fig. 4 shows the line connections of a "Series Multiple," made up of 5-point switchboard jacks and equipped with hand restoring indicators connected to the answering jacks.

As the multiple jacks are in strips of 20, 42-wire cable is run from the test jacks to the first multiple jack. The cable from this point, throughout the multiple to the answering jacks, is 63-wire cable. This provides three wires for each circuit, two for the line wires and one for the engaged test. The line wires of the 63-wire cable from the inner contacts of the first multiple are connected to the outer springs of the jack of the

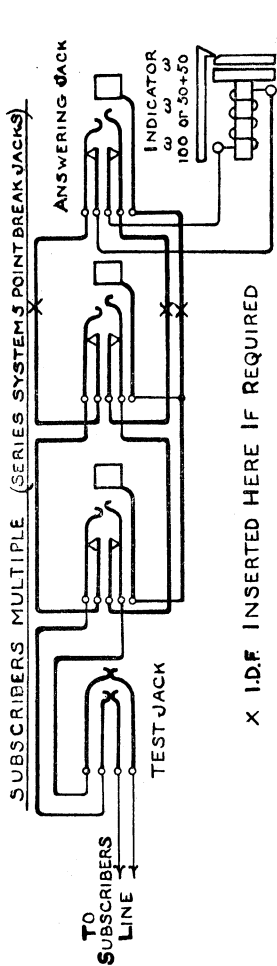

X I.D.F. INSERTED HERE IF REQUIRED

Fig. 4.

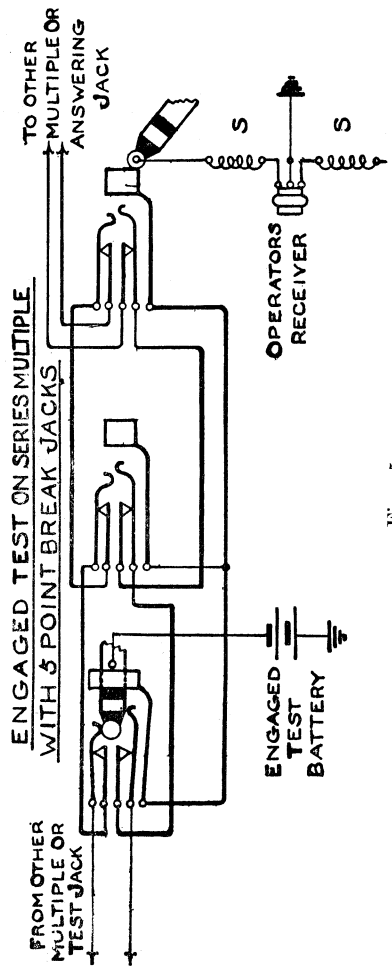

Fig. 5.

second multiple, and the cable from the inner contacts of the second multiple is connected to the outer springs of the third multiple. This method of wiring is repeated to the last multiple. The wiring from the inner contacts of the last multiple jack is connected to the I.D.F., or, when no I.D.F. is fitted, direct to a jack immediately in front of the operator and known as the "answering" or "local jack." These jacks are in strips of 10. The cables from the inner contacts of the answering jacks are carried to the indicators.

The third wire is connected throughout to the bush or frame of the jack and is used for the **Engaged test**. The engaged test is necessary to enable the operator to ascertain whether the subscriber wanted is already engaged on another portion of the switchboard. From Fig. 5 it will be seen that, when a plug is inserted in a jack, the third connection or sleeve of the plug places the engaged test battery on all the bushes of the jacks connected together by the third wire. When an operator taps one of these jack bushes with the tip of a plug whilst her telephone is in circuit, a current will circulate *via* the bush of the jack, the tip of the plug, through one half of the secondary of the induction coil S and one half of the receiver R to earth. The flow of current produces a click in the receiver denoting that the line is engaged.

Fig. 6 shows the engaged test connections when 7-point break jacks and two-way plugs are fitted. In this case the test spring of the jack is not rigidly fixed to the bush, and when a plug is inserted, the test spring is pressed away from the bush by a piece of insulation, between it and the line spring, and makes on to an outer contact. This outer contact is common to each of the jacks in the strips of 20 and is connected to an earthed battery. This battery takes the place of the one in Fig. 5, which is shown connected to the third conductor of the plug. The engagement of the test spring and outer contact places battery on to the third wire and remaining test springs which are normally in contact with the bushes of their jacks, thus enabling an operator to test if a line is engaged, as explained in connection with Fig. 5.

The Multiple so far described is known as the **Series or Break Jack System**, because, when a plug is inserted in a jack, the calling indicator is disconnected from the line. The fact that the electrical circuit is dependent on series contacts made by the jacks springs, makes it important that the Switchboard should be maintained free from dust and damp.

### BRANCHING MULTIPLE.

When this system is employed, 3-point branching jacks, 3-way plugs and self-restoring indicators are usually fitted.

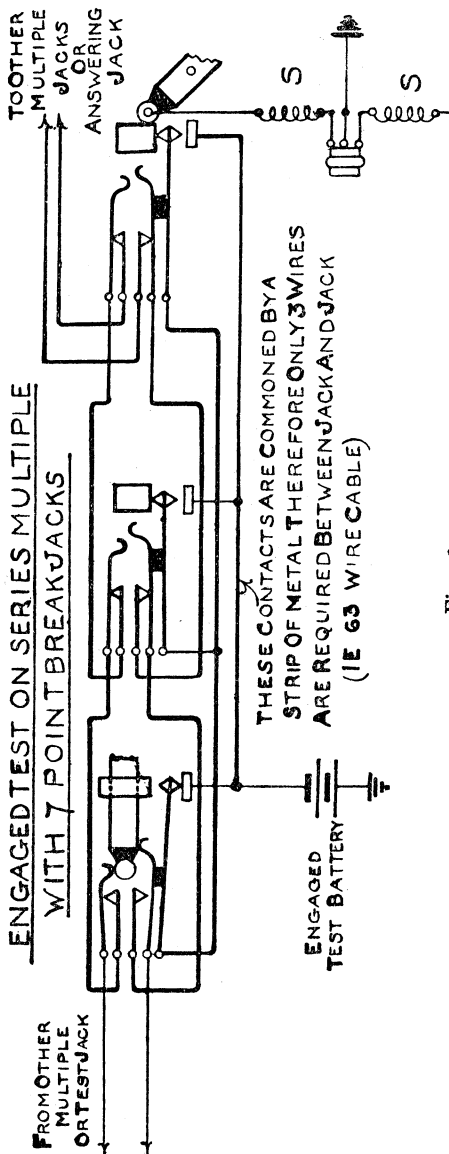
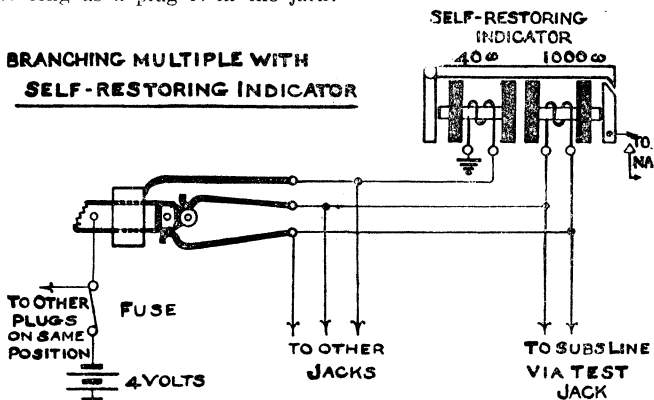

Fig. 6.

In wiring the jacks on a **Branching Multiple**, the line wires are branched from the same tabs on each jack, thus eliminating jack contacts. The line coil of the indicator, which is permanently across the line, has a resistance of  $1,000\omega$  and is iron jacketed. It thus has high self-induction, and consequently does not interfere with speech currents, and prevents overhearing between adjacent circuits. The  $40\omega$  coil is the restoring coil, and when a plug is inserted in a jack, current flows *via* the sleeve of the plug, the barrel of the jack, restoring coil of the indicator to earth. The indicator is then restored and locked so long as a plug is in the jack.



The earthed battery on the sleeve of the plug also provides means for the engaged test being taken, as previously described under Fig. 5.

### THE SWITCHBOARD.

The traffic handled on a Switchboard may be divided into two main groups, viz. :—

**Originating Traffic**, *i.e.*, calls originated by subscribers on the exchange.

**Incoming Traffic**, *i.e.*, calls incoming over junctions from other exchanges.

In the larger exchanges it is convenient to assign certain operators' positions for each kind of traffic, and the positions where the originating calls are answered are termed "**A**" positions. The positions on which the incoming traffic is handled are termed "**B**" positions.

The Switchboard is usually made up of Sections having a capacity for 300 answering jacks and indicators. The most

common type of **Multiple Section** with hand-restored indicators comprises 6 jack panels, and is arranged for either 3 or 4 operators' positions.

The indicators are placed just above the key shelf and the cords on a shelf above them. In the jack panels the answering jacks are at the bottom, the outgoing junction jacks immediately above, and the subscribers' multiple jacks in the upper portion. The first switchboard section is usually arranged for incoming junctions, and the subscribers' multiple passes through the jack panels in this section as in the subscribers' sections. At each end of the suite of sections it is customary to leave one operator's

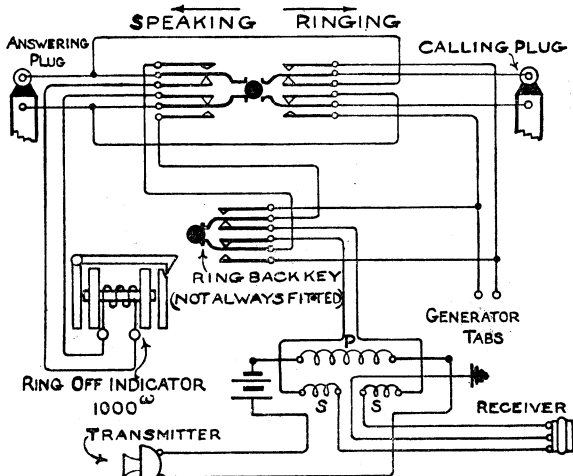

Fig. 8.—OPERATOR'S CORD CIRCUIT.

position unequipped, or to fit a special section termed a "Dummy," to allow the end operator to have a full multiple within reach.

**"A" Operator's Position.**—Each operator's position is usually equipped with from 12 to 15 pairs of cords, and associated with each pair of cords is a combined speaking and ringing key and a ring-off indicator. This circuit is shown in Fig. 8.

The answering plug is inserted into the answering jack of the subscriber calling, and by moving the key to the speaking position, the ring-off indicator is disconnected and the operator's instrument placed in circuit. When the number required is ascertained, the line is tested and, if not engaged, the calling plug is inserted into the multiple jack of the subscriber wanted, the ringing key is moved to the ringing position, and the subscriber required is rung. When the key is in its normal posi-

tion, the operator is cut out of circuit and the ring-off indicator is connected across the line. This indicator has a resistance of 1000 $\Omega$ , is wound for high inductance, and iron jacketed so that it will not interfere with speech currents. When either subscriber rings off, the indicator drops and the operator takes down the connection. In some instances a ring-back key is provided common to all the cords on the position, and is used for ringing the calling subscriber should he leave the telephone before connection is established.

The earth on the centre point of the operator's receiver is required to complete the engaged test circuit already referred to, and the reason for the insertion of the receiver between the two halves of the secondary coil "S" is in order not to disturb the balance of the line when the operator is in circuit.

### WIRING OF MULTIPLE.

The multiple cables are cut into lengths of from 8 to 10 ft. according to the distance between the multiple jack panels they are to serve. The length of the formed portion is decided by the length of the jack strip which is usually 11 $\frac{1}{2}$  in. Each strip of the same series is connected throughout the Sections, *i.e.*, in the case of numbers 1-20, from the first panel of the 1st Section to the first panel of the 2nd Section, and so on throughout the Switchboard. Fig. 9 shows a plan of a multiple and the staggered arrangement of the cable forms on to the jack strips. This is to permit the cables to lie as flat as possible, so that each layer will not take up more space than the thickness of each layer of jack strips.

### JUNCTION WORKING.

The **junction equipment** in the **larger exchanges** provides for the "**divided**" working of junctions. The junctions between any two exchanges are separated into two groups, each group being arranged to carry traffic in one direction only.

Where the number of junctions is small "**both-way**" working is used, and the junctions are terminated at each end on jacks and indicators.

In "**divided**" working the junctions from each exchange are in **two groups** as previously stated, one group being the "**Incoming**" and the other the "**Outgoing**" junctions.

The outgoing junctions are multiplied throughout the Switchboard so that each operator has access to all the distant exchanges. There are two systems of working, dependent on the number of junctions in the group. First, "**Ringing**" junctions, in which the operator signals the distant exchange by ringing, as in calling a subscriber in the usual manner, and second, "**Order Wire**" junctions. The latter system is used when the number of junctions in the group is large enough to warrant setting aside one circuit in each group to act as an "Order

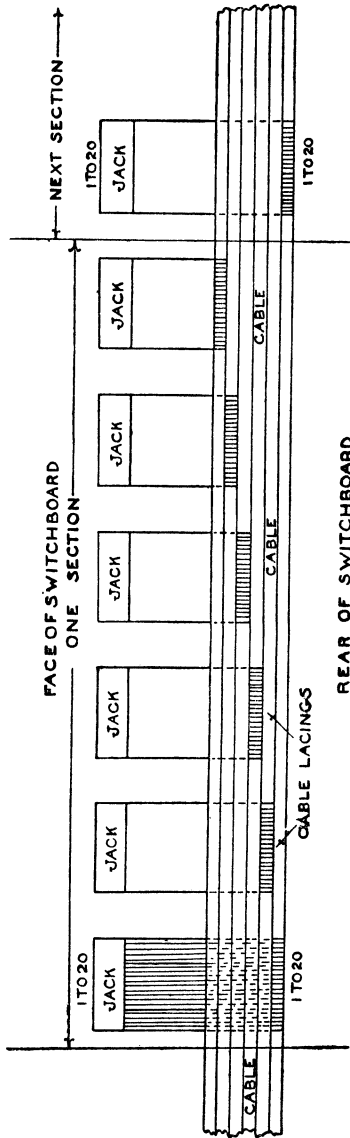

Fig. 9.

PLAN OF MULTIPLE CABLE FORMS.



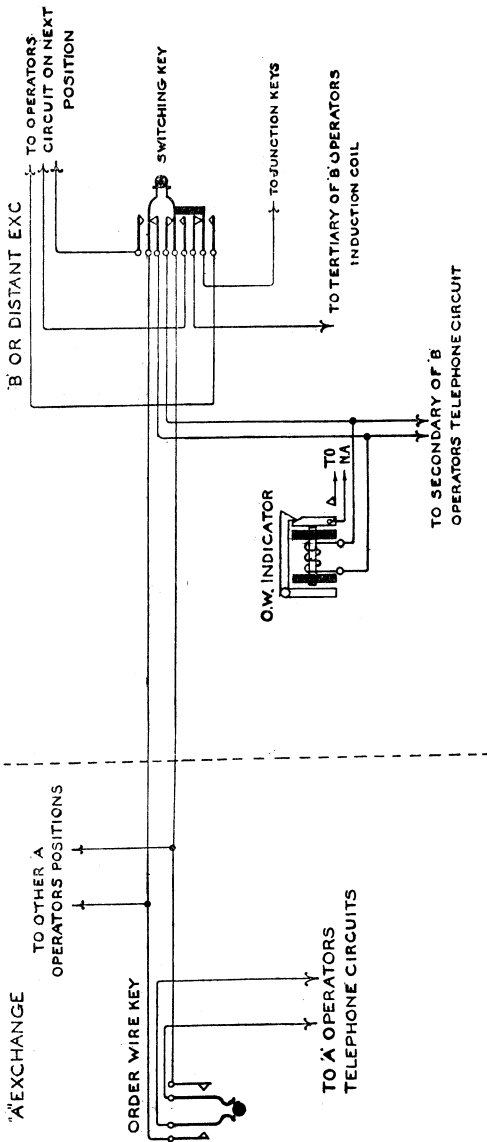

Fig. 10.  
ORDER WIRE.

Wire." The "Order Wire" is connected directly to the telephone of the "B" operator at the distant incoming end, and to a key on each "A" operator's position at the outgoing end, thus allowing the "A" operator to "order" or ask for the number she requires at the distant exchange. Fig. 10 shows such a circuit, and it will be noted that there is an indicator bridged across the line to provide a signal during the slack periods when the "B" operator is not listening in. The Switching Key is for switching over the order wire to another "B" operator's position when desirable.

An order wire junction circuit generally used is shown in Fig. 11. This shows the operator's circuit, together with a test and ringing key "K." It may be mentioned that speaking facilities are not necessary on the junction, because the call is controlled by the "A" operator. The "B" operator's duty is merely to connect and ring the required subscriber and disconnect on receipt of the clearing signal.

Each junction is terminated, at the incoming end, on a plug to extend the junction to the subscriber required. The operation of the circuit is as follows:—The "A" operator passes the demand over the order wire and the "B" operator assigns a junction. The "A" operator makes a connection with the jack on the outgoing junction multiple, and if the required subscriber is disengaged, the "B" operator places the plug, associated with the junction already assigned, in the multiple jack of the required subscriber, rings, and the call is through.

When junctions are operated by "order wire" it is necessary to provide "busy-back" circuits to enable the "B" operator to inform the "A" operator when a subscriber's line asked for is engaged. A typical circuit is shown in Fig. 12, and when a line is engaged the "B" operator inserts the plug, of the junction assigned, into a busy-back jack and places the key "K" (Fig. 11) in the through position. The busy-back jacks, of which there are provided about five per "B" operator's position, are connected to an interrupter, worked on the ringing machine, which opens and closes the circuit at intervals of about half a second, and at the same time provides an intermittent buzzing noise from the induction coil. The "A" operator hears the buzz, takes down the connection from the junction, and informs the calling subscriber that the number he requires is engaged. When the "A" operator withdraws the plug from the junction, the "B" operator receives a clearing signal (see description later).

Referring again to Fig. 11 it will be noted that the operator's induction coil has three windings, the Primary, Secondary, and Tertiary, and the circuit of the "Engaged Test" is as follows:—

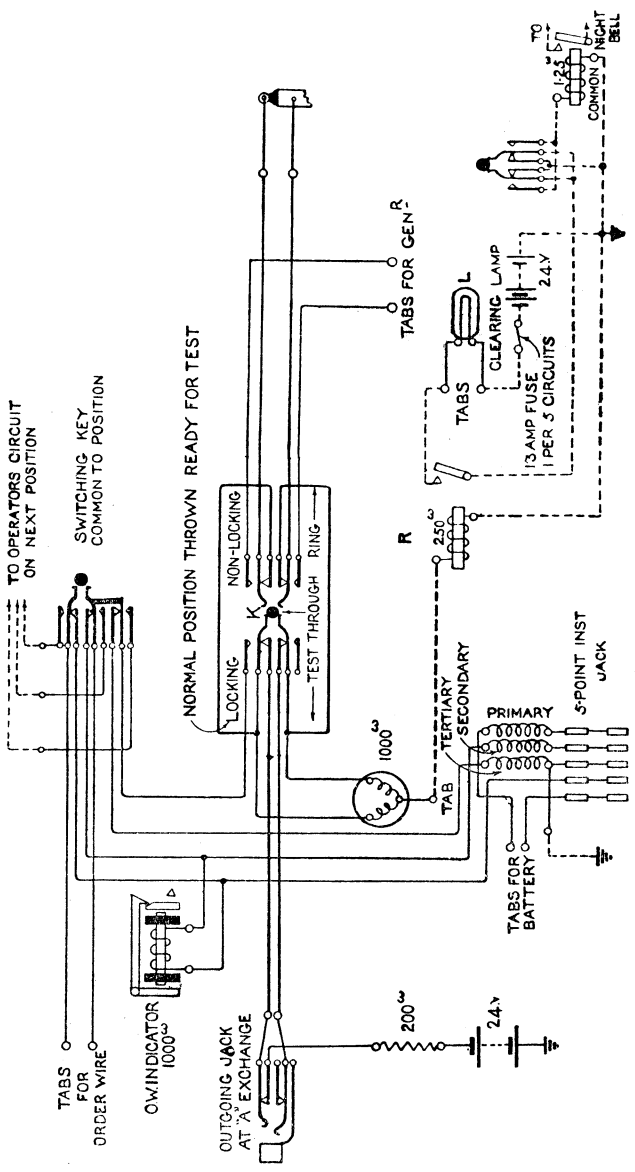

Fig. II.  
WIRING OF INCOMING ORDER WIRE JUNCTIONS.

Earthed battery is connected to the barrel of the subscriber's jack which is engaged, tip of "B" operator's plug, contacts of Key "K" and also the switching key, then through the Tertiary winding of the induction coil to earth; by inductive action a click is heard in the operator's receiver. The third winding is necessary because speaking keys are not fitted and therefore the engaged test could not be taken in the usual way.

When the subscriber rings off the "A" operator withdraws her plug, which places battery on to the A line. This operates the relay R, and by the Lamp L gives the clear to the "B" operator, who, after withdrawing her plug, throws the key "K" to the normal or "test" position.

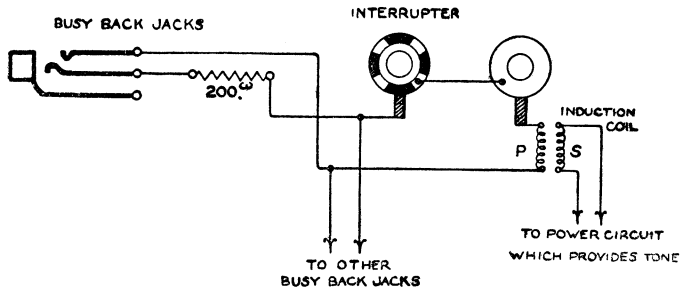

Fig. 12.—BUSY BACK CIRCUIT.

The incoming junctions may also be "jack ended" as shown in Fig. 13, and in that case double cord working is used, the circuits being the same as already described in connection with Fig. 8.

#### LAMP SIGNALLING.

The calling and clearing signals so far described have been of the indicator type, either hand or self-restored, but lamp signalling is sometimes used in both Branching and Series Multiple Systems. The lamps are mounted in strips the same length as the answering jack strips, and each lamp is centred directly under its answering jack. The glow of the lamp is a direct guide to the answering jack and saves the operator the trouble of locating the answering jack of the caller as is necessary with indicators. A greater number of signals can be concentrated in front of one operator and in more direct line of vision. The signalling circuit for a series multiple is shown in Fig. 14.

The subscriber calls by ringing through the 500 coil of the Relay "C.R.", and immediately the relay operates, a circuit is completed from the 24v. battery through the pilot relay "P.R.", the 400<sup>w</sup> coil of relay "C.R." and lamp in parallel, the inner contacts of the "A" springs on the jacks, to earth, thus

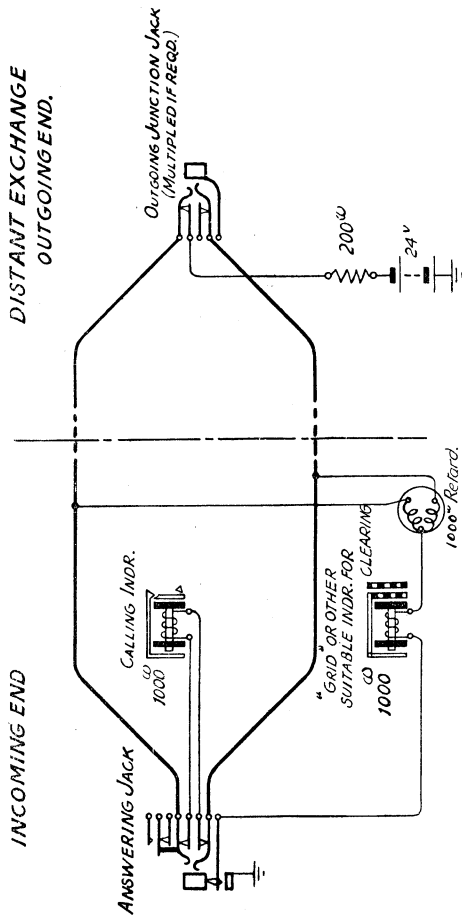

Fig. 13.

MAGNETO EXCHANGE. INCOMING RINGING JACK ENDED JUNCTION CIRCUIT.

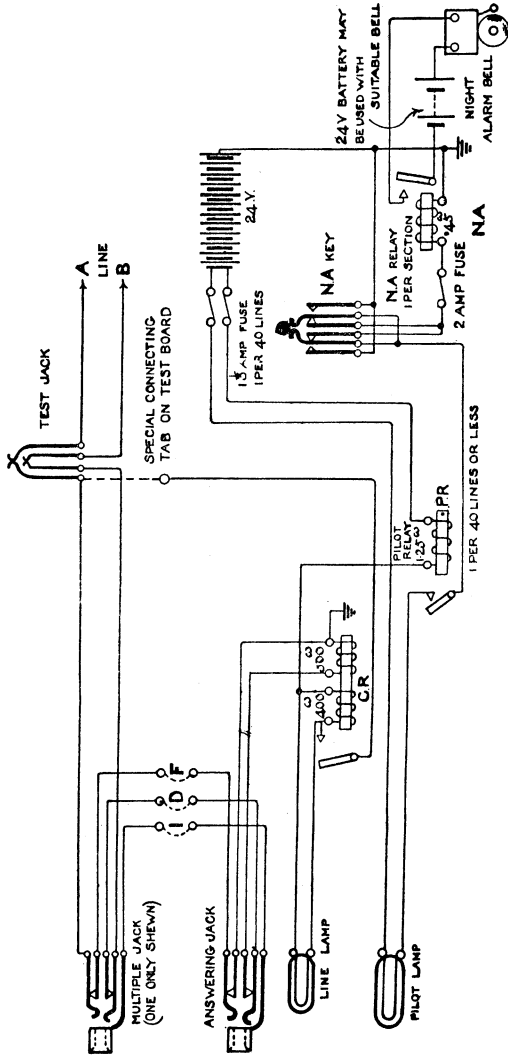

Fig. 14.

LINE CIRCUIT. LAMP CALLING MAGNETO SYSTEM. BREAK JACKS.

retaining the relay and providing a permanent signal on the lamp. When the operator plugs into the answering jack tee circuit through the retaining coil (400 $\Omega$ ) of the relay "C.R." is broken and the armature falls back, cutting off battery from the lamp. The pilot relay "P.R." is common to the calling lamps on the operator's position and is of 1.25 $\Omega$  resistance. When actuated it completes the pilot lamp circuit.

The pilot lamp is usually larger than the calling lamp and is placed prominently in a panel directly in the operator's line of vision. When any calling lamp glows the pilot lamp also glows and assists in attracting the operator's attention.

The key "N.A." is used to bring into circuit the night bell during slack periods. If the key is thrown it cuts off the coil of the Night Alarm relay "N.A.," but in the position shown in Fig. 14 the relay "N.A." will operate each time a subscriber calls, and on closing its contacts will ring the Night Alarm bell.

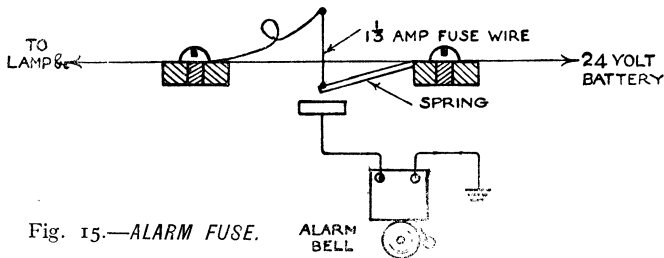

Fig. 15.—ALARM FUSE.

Where lamp signalling is introduced it is usual to employ secondary cells, and in this case it is necessary to provide fuses in the battery leads, so that, if a fault occurs, it will affect only a small proportion of the lines. The leads from the battery are fitted with 1 1/2 amp. fuses at the battery bus bars, and led to the relay armature common connections on the relay rack. Each lead serves a group of calling lamps (usually not more than 40 lamps) or a group of pilot lamps (usually 3 or 4, according to the number of operators' positions per section). The calling lamps take about 0.11 amp. and the pilot lamps rather more. The leads must therefore be of such conductivity that the maximum current may be carried without risk of overheating. The fuses are generally of the alarm pattern and consist of a spring held in tension clear of the alarm contact by 1 1/2 amp. fuse wire, see Fig. 15. When the fuse is blown the spring makes contact and completes the alarm bell circuit.

The fuses are mounted on a fuse panel and when blown can be replaced readily.

A line circuit with lamp calling and a branching multiple is shown in Fig. 16.

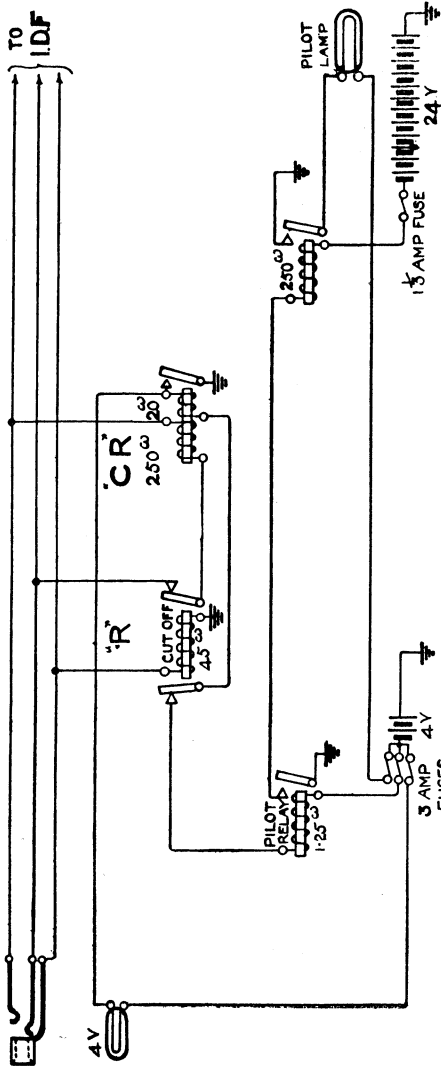

Fig. 16.

LINE CIRCUIT LAMP CALLING. MAGNETO SYSTEM BRANCHING JACKS.



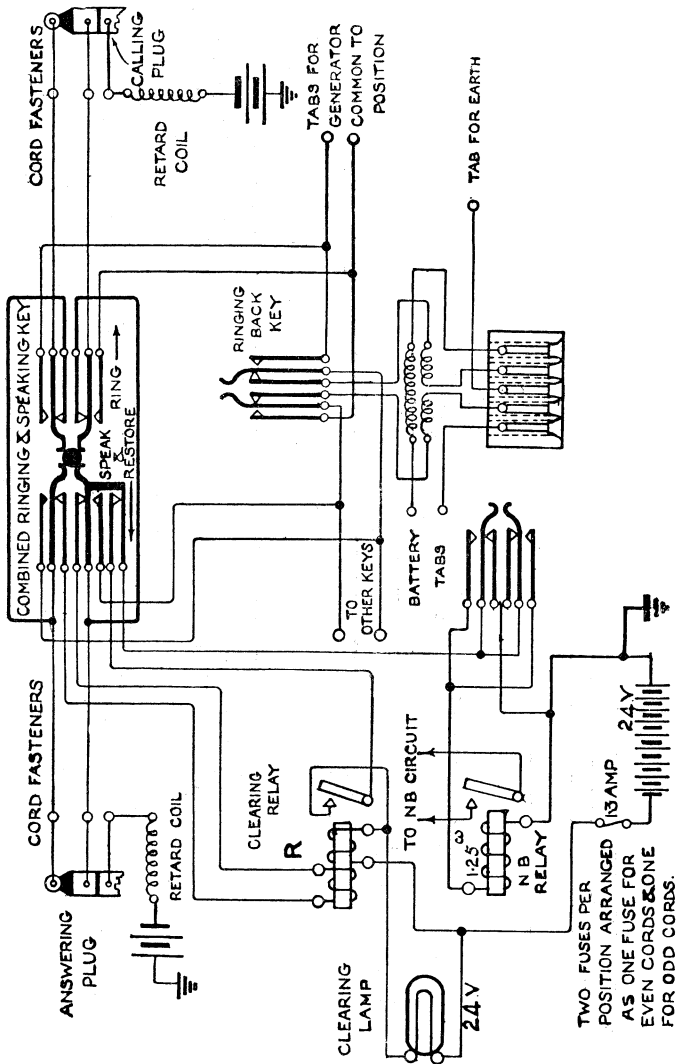
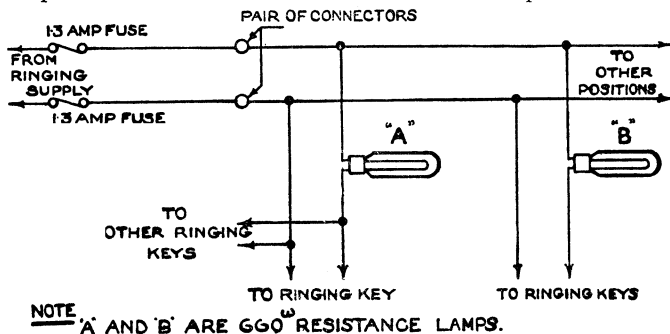

Fig. 17.  
CORD CIRCUIT. MAGNETO SYSTEM WITH LAMP CLEARING.

As there are no inner contacts on the jacks, a cut off relay "R" is required. The subscriber calls as already described in connection with Fig. 14, and when the operator inserts a plug in the jack, the cut-off relay is actuated, which disconnects the 250<sup>ohm</sup> coil of the calling relay "C.R." from the line. This is accomplished by the battery on the sleeve of the plug.

Fig. 17 shows the arrangement of a cord circuit which provides for this and also for a lamp clearing signal. When the subscriber rings off, the back coil of the relay "R" is energised, pulling up the armature and completing the retaining coil and lamp circuit. This circuit is broken when the operator throws



**NOTE** 'A' AND 'B' ARE 660<sup>ohm</sup> RESISTANCE LAMPS.

ONE TO EACH POSITION.

Fig. 18.

#### RINGING DISTRIBUTION.

her key to the speaking and restoring position, thus disconnecting the circuit through the lamp and the retaining coil of the relay "R."

#### RINGING DISTRIBUTION:

In the larger exchanges two ringing machines are used, one for day and the other for night working, or as a relief machine in case of a breakdown. Fig. 18 shows a ringing distribution circuit.

It will be seen that fuses are provided for the mains, and 660<sup>ohm</sup> resistance lamps are inserted in each exchange position ringing lead. The fuses protect the machines, and the lamp resistances provide against the shunting of the current when an operator is ringing on a faulty line. If hand generators are fitted, the positions on each section are provided with switches to switch them into circuit.

==== **LIST OF** ====

# Technical Pamphlets for Workmen

(Continued.)

---

---

**GROUP E.**

1. Automatic Telephone Systems.

**GROUP F.**

1. Subscribers' Apparatus C.B.
2. Subscribers' Apparatus C.B.S.
3. Subscribers' Apparatus Magneto.
4. Private Branch Exchange—C.B.
5. Private Branch Exchange—C.B. Multiple, No. 9.
6. Private Branch Exchange—Magneto.
7. House Telephones.
8. Wiring of Subscribers' Premises.

**GROUP G.**

1. Secondary Cells, Maintenance of.
2. Power Plant for Telegraph and Telephone Purposes.
3. Maintenance of Power Plant for Telegraph and Telephone Purposes.
4. Telegraph Battery Power Distribution Boards.

**GROUP H.**

1. Open Line Construction, Part I.
2. Open Line Construction, Part II.
3. Open Line Maintenance.
4. Underground Construction, Part I.
5. Underground Construction, Part II.
6. Underground Maintenance.
7. Cable Balancing.
8. Power Circuit Guarding.
9. Electrolytic Action on Cable Sheaths, etc.
10. Constants of Conductors used for Telegraph and Telephone Purposes.

**GROUP I.**

1. Submarine Cables.

**GROUP K.**

1. Electric Lighting.
2. Lifts.
3. Heating Systems.
4. Pneumatic Tube Systems.
5. Gas and Petrol Engines.

**GROUP L.**

1. "Safety First" for P.O. Engineering Workers.